



StormFLO® Civil

Installation Guide

INCLUDING:

- Land development – residential and industrial
- Roads – infrastructure, stormwater, asset renewal
- Rail – stormwater run-off
- Mining – stormwater and aggressive ground
- Rural – culverts and land drainage

Flexible Pipes

StormFLO® Civil are flexible pipes. This means that as vertical loads are applied, the pipe will deflect and take advantage of horizontal soil pressure to provide additional support to the system. The interaction of the pipe and the embedment material means that both play an important role in the structural performance of the pipeline.

Flexible pipes have shown excellent performance in buried applications and have been thoroughly researched in both field installations and laboratory studies.

Properly installed pipes, in which the specified embedment material is placed and compacted to the required level, have characteristically low deflections because the pipe deflection follows the soil settlement.

After initial compaction and settlement, applied vertical loads have very little effect on deflection. The use of flexible pipes in all buried applications

including, under road pavements is well established in Australia and throughout the world.

Where StormFLO® Civil pipes are installed at depths between 0.8m and 6m in normal soils and recommended installation practices are followed there is generally no need for structural design calculations. In these typical installations, deflection can be reliably predicted from a design chart based on the compaction level of the embedment, or using our design guide on the Vinidex website.

For installation conditions at greater depths or in poor soils, a design methodology for flexible pipes is clearly set out in AS/NZS 2566.1 "Buried flexible pipelines. Part 1: Design". This Standard uses the pipe characteristics and material properties, installation conditions and external loads to predict pipe deflection, strain in the pipe wall and resistance to buckling which are compared against conservative allowable limits.

StormFLO® Civil

StormFLO® Civil 6m pipe dimensions

Vinidex Code	Nominal Diameter (mm)	Effective Length (m)	Overall Length (m)	Approximate Pipe Mas (kg/length)	Number of Pipes per Crate	Semi Truck Load	B-Double Truck Load
29520	225	5.96m	6.10m	19	12	144	216
29521	300	5.88m	6.05m	26	6	72	108
29522	375	5.79m	6.02m	47	4 or 6	60	90
29523	450	5.78m	6.00m	73	2	40	60
29524	525	5.69m	5.96m	100	2	32	48
29525	600	5.56m	5.90m	113	3	18	27
29405	900	2.81	135.7	2		16	24

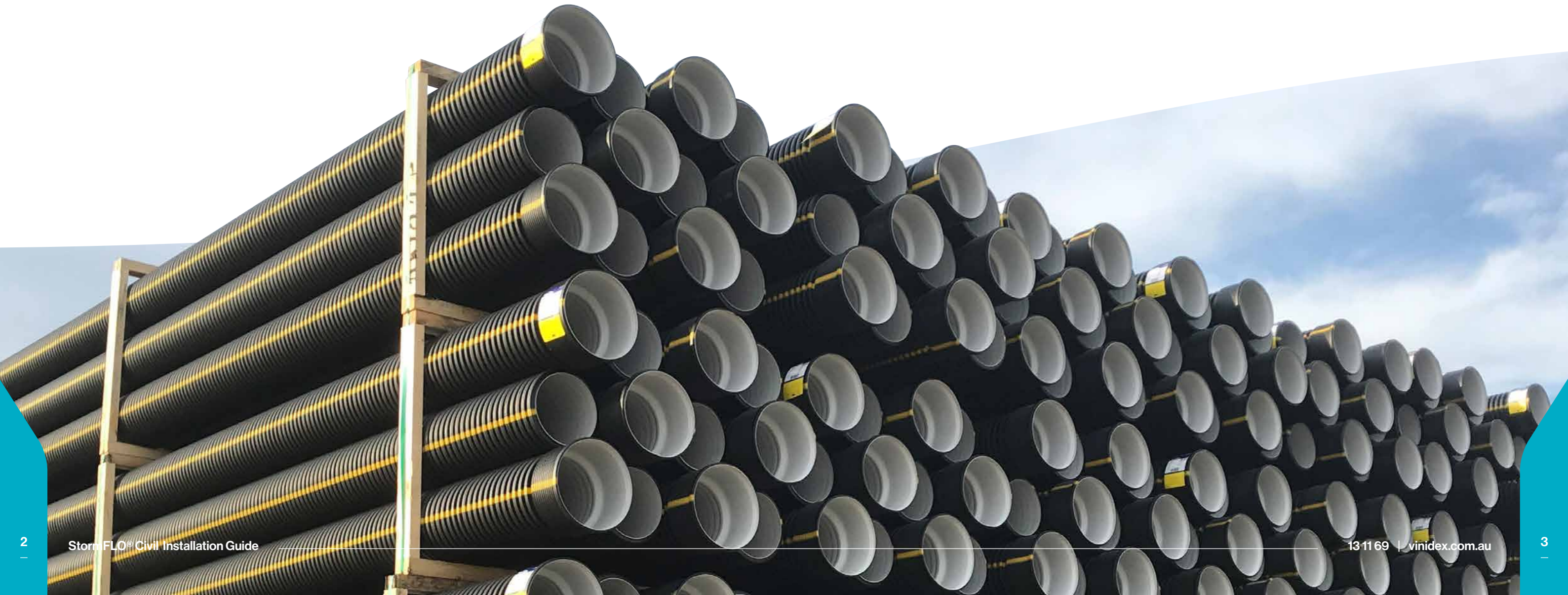

Handling & Storage

StormFLO® Civil pipes are relatively light weight and smaller sizes can be lifted manually. Note that correct PPE and safe lifting practices should always be used. Care should also be taken when pipes are loaded, unloaded, stacked or distributed on sites to avoid damage to the pipe.

When pipes are lifted mechanically, approved and certified web or rope slings should be used. Transport should not have sharp projections which could cause damage to pipes. Pipes should not be dragged along the ground as this can damage the pipe, causing difficulty with jointing and testing.

StormFLO® Civil pipes should be stacked on flat firm ground, which has been cleared of debris and hazardous combustible vegetation. Pipes should be laid flat on transverse bearers at least 75mm wide at maximum 1.5m centres.

Pipe sockets should be supported so that the ends are free from loading, with sockets in each layer opposite to the previous layer. Different sizes are best stacked separately. If this is not practical, then stack with the largest pipes at the base.

Framed crates must be stored timber on timber (sizes 150, 225 and 300 only). The height of the pipe stacks should be limited to prevent distortion and excessive ovalisation.

If pipes are to be nested (smaller diameter pipes stored inside larger diameter pipes) for long periods, stacks should not exceed 2m in height.

Trench Excavation

All trenches are potentially dangerous and proper care should be taken to ensure the stability of the trench wall and the safety of all workers. The trench should not be excavated too far in advance of pipe laying and should be backfilled as soon as possible.

Minimum Trench Width

The trench width should be as narrow as is practicable, but wide enough to allow adequate compaction of the haunch zone and the making and inspection of joints. AS/NZS 2566.2 sets out the minimum trench dimensions for StormFLO® Civil as shown in Table 1.

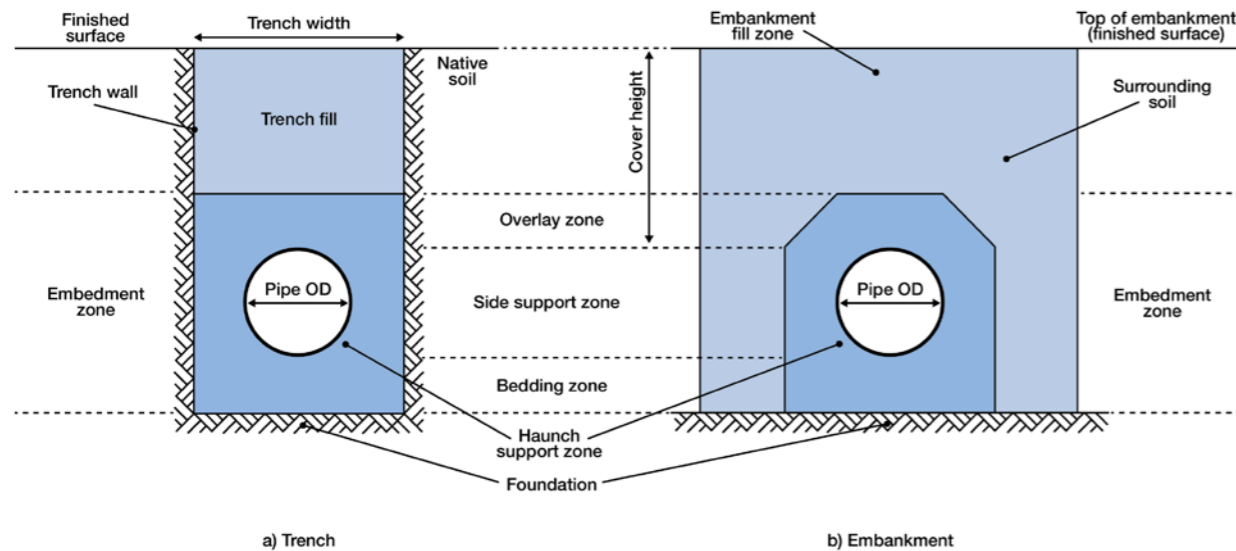

TABLE 1: MINIMUM TRENCH DIMENSIONS

Nominal Diameter (mm)	Minimum Trench Width (mm)	Minimum Depth of Bedding Zone (mm)	Minimum Depth of Overlay Zone (mm)
225	560	100	150
300	745	100	150
375	830	100	150
450	1115	150	150
525	1200	150	150
600	1280	150	150

Pipes in Parallel

Where pipes are laid in parallel, the minimum spacings between pipelines are given below.

TABLE 2: MINIMUM SPACINGS BETWEEN PARALLEL PIPELINES

Nominal Diameter (mm)	Minimum Spacing (mm)
225	150
300	200
375	200
450	300
525	300
600	300

The trench should be excavated deep enough to allow for the specified grade, the required depth of underlay and the minimum cover.



Selection of Embedment Material

Embedment material for StormFLO® Civil pipes should preferably be granular, free-flowing material. This type of embedment material requires less compactive effort to provide support for the pipe and minimises soil settlement. The table below provides typical gradings for single-size aggregates suitable for use as embedment material for StormFLO® Civil pipes.

Table 3: Typical aggregate grading

SIEVE SIZE (mm)	% PASSING BY MASS		
	Nominal size of single-size aggregate		
	10mm	7mm	5mm
26.5	-	-	-
19	-	-	-
13.2	100	-	-
9.5	85-100	100	-
6.7	-	85-100	100
4.75	0-20	-	85-100
2.36	0-5	0-20	0-40
0.075	0-2	0-2	0-2

Where sand is more readily available, a typical sand grading is shown below.

Table 4: Typical sand grading

SIEVE SIZE (mm)	% PASSING BY MASS
4.75	100
2.36	90-100
1.18	85-100
0.6	70-100
0.3	50-100
0.15	0-40
0.075	0-5

In cases of reduced cover, it may be preferable to use a cement stabilised sand/gravel as the embedment material (including bedding, side support and overlay zones). According to Table L2 of AS/NZS 2566.2, the cement stabilised material should have a cement content of 6-10%, a moisture content of 10%, and have an unconfined compression strength of 1.7MPa, as determined from cylinder specimen at 7 days.

In cases of excessive cover, selecting a smaller sized aggregate will assist with achieving the desired pipe haunching, and should be considered.

In cases where it is difficult to achieve mechanical compaction of the bedding material, controlled low strength material (CLSM) may be used as an alternative material. CLSM, also known as slurry fill, flowable fill, flowable mortar, soil-cement slurry, unshrinkable fill or controlled density fill, should achieve a compressive strength in the range of 0.6 MPa to 3.0 MPa, depending on cement content.

When placing CLSM, care should be taken to prevent flotation of the pipe by selecting a lift thickness appropriate to the diameter of the pipe, or ballasting the pipe with sandbags. Further details are available in Appendix K of AS/NZS 2566.2.

Placing and Compacting of Embedment Material

The embedment material should be placed and graded to invert level, and compacted to a minimum 95% Modified Maximum Dry Density or 70% Density Index, depending on the selected material. In conditions where the trench bottom is wet, soft or irregular, it may be necessary to first stabilise, fill and level, and compact the base. Place and compact material in the pipe bedding zone to figures in Table 1.

In order to ensure uniform support along the pipe barrel, a small indentation should be excavated in the pipe bedding zone to accommodate the pipe sockets.

Side support and overlay material should be placed in a manner to ensure:

- a. uniform distribution and compaction of embedment material, especially under the haunches of the pipe;
- b. the material relative compaction is consistent with design;
- c. pipe distortion is minimized;
- d. the pipe is not damaged; and
- e. the specified pipe alignment, level and grade is maintained

The pipe overlay material should be levelled and compacted in layers, to a minimum height of 150mm above the crown of the pipe, or as specified.

Cutting of Pipes

StormFLO® pipes may be cut anywhere along their length as required, always ensuring that safe work practices are followed. The cut should be made in the valley between the corrugations at right angles to the axis of the pipe. No end treatment or chamfer is required.

StormFLO® Civil pipes can be safely cut using any saw suitable for cutting timber. This can be a manual or powered saw.

Any saw that uses oil as a lubricant is not recommended.



StormFLO® Civil

Structural Design

Under general gravity drainage and sewer pipe laying conditions, detailed calculations predicting pipe performance are not necessary. Following an extensive study of installed pipe performance, The European Plastic Pipe and Fitting Association (TEPPFA) findings, that are now part of the European standard, concluded that final deflection of pipes was controlled by the settlement of the soil after installation. Where installation was controlled, or self-compacting granular materials were used, pipe deflections were consistently low regardless of installation depth and traffic or other loads.

In the graph below:

“Well” compacted refers to bedding material placed and compacted around the pipe to a minimum 94% dry density ratio, in layers of maximum 300 mm thickness, to a minimum depth over the pipe of 150mm; and

“moderate compaction refers to bedding material placed and compacted around the pipe to 87% to 94% dry density ratio, in layers of maximum 500mm thickness, to a minimum depth over the pipe of 150mm.

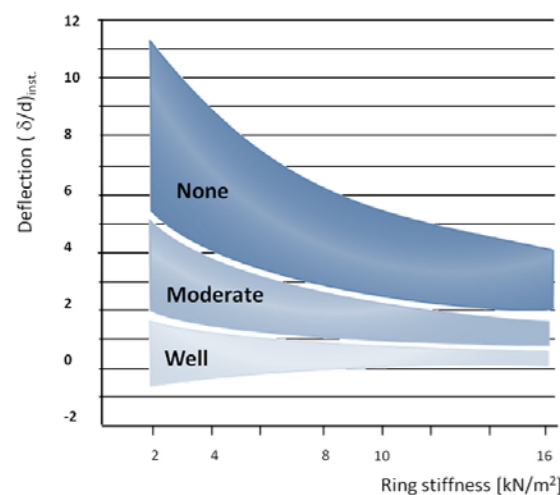

Where StormFLO® Civil pipes are to be installed in normal conditions at depths up to 6m such that the depth to diameter ratio is at least 2, design calculations are not required. Simply following the recommended installation procedures will ensure that deflections are controlled. This is particularly true for installations under roadways, where the level of compaction required to prevent subsidence of the pavement also provides a highly supportive structural environment for the pipe.

For unusual conditions, or depths greater than 6 metres, design calculations may be performed in accordance with AS/NZS 2566.1. The structural design aspects of buried flexible pipes to be considered are vertical deflection, ring bending strain and buckling.

The following typical values in Table 2 may be used in pipe design.

To assist engineering consultants and designers Vinidex have a Design Calculator to assist with Buried Flexible Pipe designs.

The graph shows deflection immediately after installation. Final pipe deflection after soil settlement are expected to be 1% higher for well compacted granular soil, 2% for moderately compacted granular soil and 3-4% where no compaction has taken place.

Table 2: Typical structural design properties of StormFLO® Civil

Property	Symbol	Value
Short Term Stiffness - StormFLO®	S_{D1}	8000 N/m/m
Allowable Long Term Deflection	$\frac{\Delta_{yall}}{D}$	7.5%
Allowable Long Term Ring Bending Strain	ϵ_{ball}	4%
Long Term Stiffness - StormFLO®	S_{DL2}	3900 N/m/m

Hydraulic Design

StormFLO® Civil pipes are normally sized to accommodate maximum design discharge when flowing full. The discharge rates in Tables 3 through 5 on Pages 13 to 15 for StormFLO® Civil pipes flowing full are based on the Colebrook-White formula which is recognised by engineers throughout the world as the most accurate basis for hydraulic design over a wide range of flow conditions.

In addition to friction losses in the pipeline, a pressure drop will occur due to energy loss at any change in the direction of flow or pipeline cross section. In long pipelines, these “form losses” are usually small in comparison to friction losses. However, they may be considerable in pipelines with many fittings or in short pipes such as in culvert applications, where entry and exit losses may dominate. For more information on form losses, consult Vinidex.

The Colebrook-White formula expresses velocity as:

$$V = -2 * \sqrt{2gD \frac{H}{L}} * \log_{10} \left[\frac{k}{3.7D} + \frac{2.51\nu}{D \sqrt{2gD \frac{H}{L}}} \right]$$

Where:

- V = Velocity (m/s)
- H/L = Pipe Gradient, i.e. friction head loss / pipe length (m/m)
- D_i = Internal Diameter (m)
- k = Colebrook-White roughness coefficient (m)
- ν = kinematic viscosity of water (m^2/s)
 $1 \times 10^{-6} m^2/s$ for water at 20°C
- g = acceleration due to gravity ($9.8m/s^2$)

And

Where: Q = flow rate (m^3/s)

$$Q = V * \frac{\pi D^2}{4}$$

Choice of Roughness Coefficients

AS2200 - Design charts for water supply and sewerage - recommends k values in the range 0.003 to 0.015mm for clean, concentrically jointed thermoplastics pipes and AS3500.3 - National plumbing and drainage, Part 3 Stormwater drainage - specifies 0.015mm for design of plastics stormwater pipe drains for normal conditions.

However, it is important to note that factors such as slime growth and accumulation of debris can affect the selection of roughness coefficient in some circumstances.

In addition, local utilities may have preferred values for design of their systems.

For partial flow, consult Figure A for adjustment factors.

FIGURE C: ADJUSTMENT FACTORS

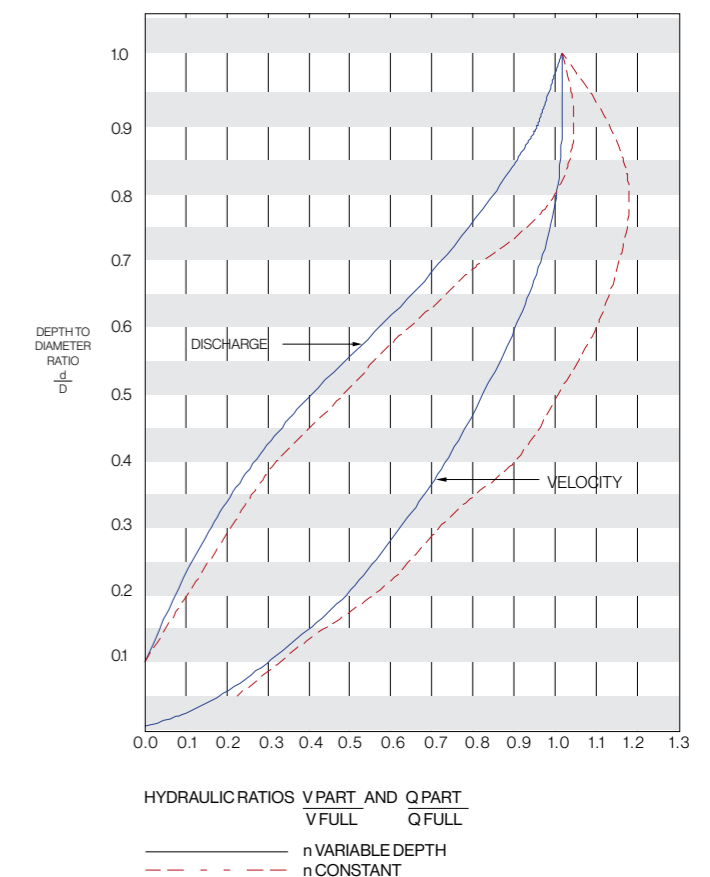

Table 3: Full discharges and velocities DN225 - DN300

Gradient H/L	Velocity/ Discharge k (mm)	DN 225 Di = 0.218				DN 300 Di = 0.294			
		0.003	0.006	0.015	0.03	0.003	0.006	0.015	0.03
		1/20	m/s	4.2	4.2	4.0	3.9	5.1	5.0
	L/s	157	155	151	145	345	340	330	318
1/30	m/s	3.4	3.3	3.3	3.1	4.1	4.0	3.9	3.8
	L/s	126	125	121	118	277	274	267	258
1/40	m/s	2.9	2.9	2.8	2.7	3.5	3.5	3.4	3.3
	L/s	108	107	104	101	237	235	229	222
1/50	m/s	2.6	2.5	2.5	2.4	3.1	3.1	3.0	2.9
	L/s	95	95	92	90	210	208	203	197
1/60	m/s	2.3	2.3	2.2	2.2	2.8	2.8	2.7	2.6
	L/s	86	86	84	82	190	189	185	179
1/70	m/s	2.1	2.1	2.1	2.0	2.6	2.6	2.5	2.4
	L/s	79	79	77	75	175	174	170	165
1/80	m/s	2.0	2.0	1.9	1.9	2.4	2.4	2.3	2.3
	L/s	74	73	72	70	163	161	158	154
1/90	m/s	1.9	1.8	1.8	1.8	2.2	2.2	2.2	2.1
	L/s	69	69	67	66	153	151	149	145
1/100	m/s	1.7	1.7	1.7	1.7	2.1	2.1	2.1	2.0
	L/s	65	65	64	62	144	143	140	137
1/120	m/s	1.6	1.6	1.5	1.5	1.9	1.9	1.9	1.8
	L/s	59	59	58	56	130	130	127	124
1/140	m/s	1.5	1.4	1.4	1.4	1.8	1.8	1.7	1.7
	L/s	54	54	53	52	120	119	117	115
1/160	m/s	1.4	1.3	1.3	1.3	1.6	1.6	1.6	1.6
	L/s	50	50	49	48	111	111	109	107
1/180	m/s	1.3	1.3	1.2	1.2	1.5	1.5	1.5	1.5
	L/s	47	47	46	45	104	104	102	100
1/200	m/s	1.2	1.2	1.2	1.2	1.5	1.4	1.4	1.4
	L/s	45	44	44	43	99	98	97	95
1/250	m/s	1.1	1.1	1.0	1.0	1.3	1.3	1.3	1.2
	L/s	39	39	39	38	87	87	86	84
1/300	m/s	1.0	1.0	0.9	0.9	1.2	1.2	1.1	1.1
	L/s	36	36	35	35	79	79	78	76
1/400	m/s	0.8	0.8	0.8	0.8	1.0	1.0	1.0	1.0
	L/s	30	30	30	30	67	67	66	65
1/500	m/s	0.7	0.7	0.7	0.7	0.9	0.9	0.9	0.9
	L/s	27	27	27	26	60	59	59	58

Table 4: Full discharges and velocities DN375 - 450

Gradient H/L	Velocity/ Discharge k (mm)	DN 375 Di = 0.362				DN 450 Di = 0.4325			
		0.003	0.006	0.015	0.03	0.003	0.006	0.015	0.03
		1/20	m/s	5.8	5.7	5.5	5.3		
	L/s	596	588	569	548				
1/30	m/s	4.7	4.6	4.5	4.3	5.2	5.1	5.0	4.8
	L/s	479	473	460	444	765	755	733	708
1/40	m/s	4.0	3.9	3.8	3.7	4.5	4.4	4.3	4.1
	L/s	410	406	395	383	655	648	630	609
1/50	m/s	3.5	3.5	3.4	3.3	4.0	3.9	3.8	3.7
	L/s	363	360	351	341	581	575	560	543
1/60	m/s	3.2	3.2	3.1	3.0	3.6	3.5	3.5	3.4
	L/s	329	326	319	310	526	521	509	493
1/70	m/s	2.9	2.9	2.9	2.8	3.3	3.3	3.2	3.1
	L/s	303	300	294	286	484	480	469	455
1/80	m/s	2.7	2.7	2.7	2.6	3.1	3.0	3.0	2.9
	L/s	282	279	274	266	450	446	437	425
1/90	m/s	2.6	2.5	2.5	2.4	2.9	2.9	2.8	2.7
	L/s	264	262	257	250	422	419	410	399
1/100	m/s	2.4	2.4	2.4	2.3	2.7	2.7	2.6	2.6
	L/s	250	248	243	237	399	396	388	378
1/120	m/s	2.2	2.2	2.1	2.1	2.5	2.4	2.4	2.3
	L/s	226	224	220	215	361	359	352	343
1/140	m/s	2.0	2.0	2.0	1.9	2.3	2.2	2.2	2.2
	L/s	208	206	203	198	332	330	324	316
1/160	m/s	1.9	1.9	1.8	1.8	2.1	2.1	2.1	2.0
	L/s	193	192	189	185	309	307	302	295
1/180	m/s	1.8	1.7	1.7	1.7	2.0	2.0	1.9	1.9
	L/s	181	180	177	173	290	288	283	277
1/200	m/s	1.7	1.7	1.6	1.6	1.9	1.9	1.8	1.8
	L/s	171	170	168	164	274	272	268	262
1/250	m/s	1.5	1.5	1.4	1.4	1.6	1.6	1.6	1.6
	L/s	151	151	149	146	242	241	238	233
1/300	m/s	1.3	1.3	1.3	1.3	1.5	1.5	1.5	1.4
	L/s	137	136	135	132	219	218	215	211
1/400	m/s	1.1	1.1	1.1	1.1	1.3	1.3	1.3	1.2
	L/s	117	117	115	113	187	187	184	181
1/500	m/s	1.0	1.0	1.0	1.0	1.1	1.1	1.1	1.1
	L/s	103	103	102	100	166	165	163	161

Table 5: Full discharges and velocities DN525- 600

Gradient H/L	Velocity/ Discharge k (mm)	DN 525				DN 600			
		Di = 0.517				Di = 0.588			
		0.003	0.006	0.015	0.03	0.003	0.006	0.015	0.03
1/20	m/s								
	L/s								
1/30	m/s	5.8	5.7	5.6	5.4				
	L/s	1221	1206	1170	1128				
1/40	m/s	5.0	4.9	4.8	4.6	5.4	5.3	5.2	5.0
	L/s	1047	1035	1006	972	1467	1450	1408	1360
1/50	m/s	4.4	4.4	4.3	4.1	4.8	4.7	4.6	4.5
	L/s	928	918	894	866	1301	1287	1253	1212
1/60	m/s	4.0	4.0	3.9	3.8	4.3	4.3	4.2	4.1
	L/s	841	833	812	787	1180	1168	1138	1102
1/70	m/s	3.7	3.7	3.6	3.5	4.0	4.0	3.9	3.7
	L/s	774	767	749	727	1086	1075	1049	1017
1/80	m/s	3.4	3.4	3.3	3.2	3.7	3.7	3.6	3.5
	L/s	720	714	698	678	1010	1001	978	949
1/90	m/s	3.2	3.2	3.1	3.0	3.5	3.5	3.4	3.3
	L/s	676	670	656	637	948	940	919	892
1/100	m/s	3.0	3.0	3.0	2.9	3.3	3.3	3.2	3.1
	L/s	638	633	620	603	896	888	869	845
1/120	m/s	2.8	2.7	2.7	2.6	3.0	3.0	2.9	2.8
	L/s	578	574	563	548	812	805	789	768
1/140	m/s	2.5	2.5	2.5	2.4	2.7	2.7	2.7	2.6
	L/s	532	528	518	505	747	741	727	708
1/160	m/s	2.4	2.3	2.3	2.2	2.6	2.5	2.5	2.4
	L/s	495	491	483	471	694	690	677	660
1/180	m/s	2.2	2.2	2.2	2.1	2.4	2.4	2.3	2.3
	L/s	464	461	453	443	652	647	636	621
1/200	m/s	2.1	2.1	2.0	2.0	2.3	2.3	2.2	2.2
	L/s	438	436	428	419	615	611	601	587
1/250	m/s	1.8	1.8	1.8	1.8	2.0	2.0	2.0	1.9
	L/s	388	386	380	372	545	542	533	522
1/300	m/s	1.7	1.7	1.6	1.6	1.8	1.8	1.8	1.7
	L/s	351	350	345	338	494	491	484	474
1/400	m/s	1.4	1.4	1.4	1.4	1.6	1.5	1.5	1.5
	L/s	300	299	295	290	422	420	415	407
1/500	m/s	1.3	1.3	1.2	1.2	1.4	1.4	1.4	1.3
	L/s	266	265	262	257	374	372	368	361

Joining Instructions

The following procedure is recommended when joining StormFLO® Civil rubber ring jointed pipes:



1. Clean the pipe socket and spigot end, making sure both are free of any dirt and grit. Any foreign matter trapped in the joint will compromise joint performance and leak-tightness of the system.



2. Install the rubber ring by stretching it over the spigot so that it seats between the first and second corrugations from pipe spigot end.



3. Ensure rubber rings are evenly fitted by running fingers around the full circumference of the pipe.



4. Apply a generous quantity of Vinidex jointing lubricant to the inside of the receiving socket. Do not lubricate the rubber ring or the valley under the rubber ring. Avoid getting lubricant under the rubber ring. This will ensure that the ring does not pick up dirt and introduce contaminants to the joint or become displaced during jointing.

HINT: To further minimize the risk of introducing grit from the embedment material into the joint, a small piece of rubber mat, poly tarp or equivalent can be temporarily placed under the socket/spigot during joint assembly.



5. Insert the leading edge of the spigot into the receiving socket. It is essential that pipes are in a straight line before attempting to make the joint. Double check that the ring and spigot is free from any grit or embedment material so as not to compromise the joint.



6. Do not apply jointing force directly to the socket. Insert a short stub of pipe in the opposite socket. The short stub can be an off-cut, 50mm longer than the socket, and can be re-used.



7. Apply even jointing force. Subject to pipe diameter and local conditions, use a crowbar (see Note) to push on a timber block on the end of the short pipe.



8. Push home the pipe until the spigot end comes into contact with the inner wall of the socket.

NOTE: The jointing force required increases with the nominal diameter of the pipe. A leverage tool such as a crowbar is generally sufficient for StormFLO® Civil pipes up to 375mm nominal diameter. For larger sizes, mechanical assistance is required. Where applying a jointing force is not practical, consideration should be given to the use of come-along or winch and rope devices.

Angular Deflection

The pipe may be deflected at the joint after jointing has been completed. Any deflection should be limited to a maximum of 1°.

Witness Mark

The rubber ring is held in position by the corrugations in the pipe. When the joint is assembled the socket inner wall will come to a natural resistance point against the sockets inner wall. As a safety measure all StormFLO® pipes have a manufactured witness mark located on the 5th Rib for DN225 & DN375 & the 4th Rib for DN300, DN450, DN525, DN600.

Depending on manufacturing tolerances, a witness mark will be either wholly within the socket, or just visible at the mouth at the completion of jointing.

Internal Lining

When StormFLO® Civil pipes are pushed fully home during assembly, the spigot end and the internal lining at the back of the socket are generally in close contact. However, due to manufacturing tolerances or where there is angular deflection at the joint a small gap may sometimes be observed. This has no effect on the sealing capability of the joint. To reduce this gap when cutting pipe, ensure the cut is clean and even throughout.

Table 6: Minimum cover over pipe as per AS/NZS 2566.1 or AS/3500.1 where stated.

Loading Condition	Minimum Cover (m)
Not subject to vehicular loading:	
a) Without pavement - i. for single dwellings; or ii. for other than single dwellings	100 300
b) With pavement of brick or unreinforced concrete	100*
Subject to vehicular loading:	
a) Other than roads: i. Without pavement ii. With pavement of - A. reinforced concrete for heavy vehicular loading B. brick or unreinforced concrete for light vehicular loading	450 100* 75*
b) Roads- i. sealed; or ii. unsealed	600 750
Subject to construction** equipment loading or in embankment conditions	750
Land zone for agricultural use	600

*Below the underside of the pavement
** Please refer in more detail to Construction Loads Table 7

NOTE: Values shown in red are to be used only where AS/NZS 3500.3 is applicable.

Backfilling

Where the finished surface is not to be paved, and surface settlement is not considered critical, ordinary fill material is suitable up to the finished surface. Under pavements where settlement of the fill material is to be controlled, a fill material that can be compacted to the required density should be used.

Trench fill should be placed on the pipe overlay and compacted as specified but generally not in layers in excess of 300mm. Complete the backfilling operation to finished surface level.

Allowable Cover for Finished Surface Levels

Minimum cover in Table 6 reflects industry standards for various load cases as per AS/NZS 3500.3. StormFLO® Civil pipes are not limited to these standards and designers/installers should source further clarification if reduced cover is required.

Construction Loads

During construction, consideration of loading during placement and compaction of fill around the pipe and any other construction loading is critical. Care must be taken to ensure that any construction loading from trench compaction and road construction equipment does not overload the pipe.

The following minimum depths (shown in table 7, below) of compacted fill over the pipe apply for the placement and compaction of fill around StormFLO® Civil pipes.

Flotation

The possibility of pipe flotation exists when StormFLO® Civil pipes are installed in areas which will be inundated, such as creek crossings, flood plains and high groundwater areas. To prevent flotation, a minimum cover equivalent to 75% of the nominal diameter is required.

Table 7: Minimum depths of compacted fill over StormFLO® Civil for construction loads

CONSTRUCTION LOAD	MINIMUM COVER	
	StormPRO^	StormFLO^
CAT140H Grader (17t)	400mm	400mm
CAT325B Excavator (25.9t)	400mm	400mm
CAT815F Compactor (20.9t)	400mm	400mm
Vibratory Trench Roller (2t)	400mm	400mm
Vibratory Plate (135kg)	400mm	400mm
Vibratory Rammer (75kg)	400mm	400mm
Smooth Drum Vibratory Roller (10t)	700mm	700mm
CATD25D Articulated Truck (42.3t)	650mm	650mm
25t Excavator and Compaction Wheel	1000mm	1000mm

^ Values derived from AS/NZS 2566.1 (short-term ring bending stiffness)



Concrete Encasement

Where concrete encasement is required, StormFLO® Civil pipes should be laid to the correct alignment and grade, supported on hessian bags filled with stabilised sand or on concrete blocks or cradles. The concrete surround should be placed so as to provide uniform and continuous support around the entire circumference of the pipe.

StormFLO® Civil joints for concrete encasement should be made with an additional rubber ring. For all sizes, the first rubber ring should be placed as between the second and third corrugations at the end of the spigot. Then the second rubber ring as per usual placement between the first and second corrugation from the spigot end.

The completed joint should also be sealed with tape to prevent concrete entering the socket during encasement.

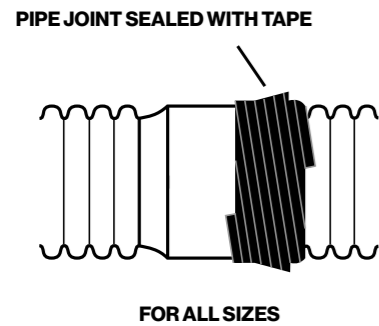

Table 8: Placement of additional rubber ring for concrete encasement

DN225 to DN600



The pipe shall be restrained and care taken to prevent movement, misalignment, distortion and / or flotation during the encasement process.

Connection to Structures

StormFLO® Civil pipes may generally be connected to rigid structures such as pits, headwalls and endwalls, both pre-cast and cast in situ. StormFLO® Civil pipes have sufficient flexibility and strain tolerance to accommodate differential settlement at the interface.

The figure below shows a typical entry or exit to a concrete structure.

Note that the hydrophilic seal is required only where a waterproof seal is critical. When required, use Hydrotite DSS0220 or equivalent.

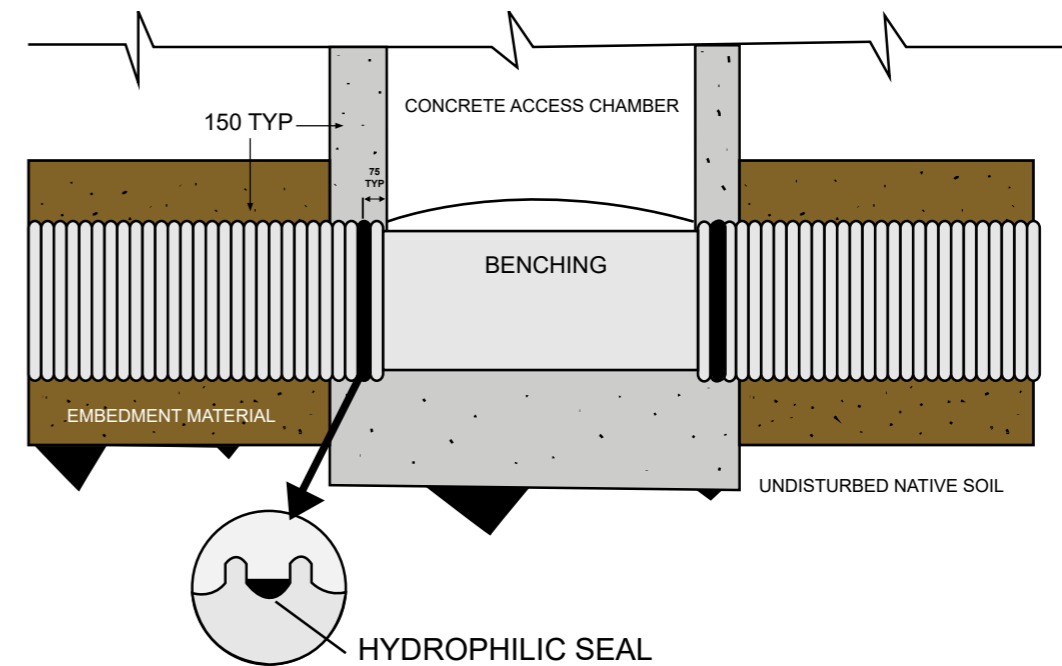

Above-Ground Installation

For above-ground applications StormFLO® Civil pipes must be adequately supported in order to prevent sagging and excessive distortion.

Clamp, saddle, angle, spring or other standard types of supports and hangers may be used where necessary. Pipe hangers should not be overtightened.

All pipe should be supported at regular intervals as detailed in the table below, always with one support located directly behind the socket. These support spacings are based on supported pipe carrying water carrying water at 20°C.

Note that where temperatures in excess of 20°C are likely, the support spacing should be reduced.







The supports should provide a bearing surface of 120° under the base of the pipes and should be at least two corrugations wide. The pipes should be protected from damage at the supports with the provision of a membrane of PE, PVC or rubber. Table 9 refers to the maximum support spacings for above-ground installations.

Table 9: Maximum support spacings

Nominal Diameter (mm)	Maximum Horizontal Spacing (m)
225	1.60
300	1.90
375	2.15
450	2.50
525	2.75
600	3.00

Stormwater Service Connections

The Vinidex PROgrommet range of stormwater service connections provide 100mm and 150mm diameter connections to StormPRO®, StormFLO® Civil and StormFLO® Rural pipes up to 900mm nominal diameter. The following procedure is recommended when installing the PROgrommet:

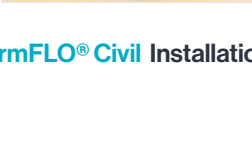
	1. Drill hole in pipe using the PROsaw. Hole centre must be located in the valley between corrugations.
	2. Inspect marking on PROgrommet to ensure the correct size for selected StormFLO® pipe.
	3. Present PROgrommet to hole with PROgrommet flange to the inside and locating wings to the outside of the pipe.
	4. Squash the PROgrommet by hand whereby the two locating wings align in the centre.
	5. With the flattened PROgrommet, form a "C" shape and offer it to the prepared hole.
	6. Position locating wings in the valley of the pipe profile.
	7. Apply Vinidex Lubricant to the inside diameter of the PRO stopper. Insert PRO stopper into PROgrommet
	8. Cut lead-in chamfer on pipe which is to be offered to PRO stopper.
	9. Mark a line on pipe showing the required insertion depth.
	10. Dry, degrease and prime the branch pipe spigot and the PRO stopper socket with a lint-free cloth dampened with Vinidex priming fluid.
	11. Apply a thin even coat of Vinidex Type N solvent cement to the internal surface of the PRO stopper socket first, then apply a heavier, even coat of Vinidex Type N solvent cement up to the witness mark on the branch pipe spigot.
	12. Insert the branch pipe spigot home to the full depth of the PRO stopper socket
	13. Hold the joint against movement and rejection of the spigot for a minimum of 30 seconds, then wipe off excess solvent cement from the outside of the joint.

Field Testing

Leakage testing is carried out to identify installation faults and sources of infiltration and exfiltration in pipelines which are required to be water-tight such as sewerage systems. Leakage testing is generally not required for stormwater drains.

Where testing is required refer to AS/NZS 3500.3 & AS/NZS 2566.2

Hydrostatic Test

Fill the pipeline with water and pressurise to not less than 20kPa at the highest point of the section being tested, but not greater than 60kPa at the lowest point of the test section. Maintain the test pressure for at least 2 hours by adding measured volumes of water if required. Each joint should be carefully examined visually for leaks, and any defects should be repaired. The pipeline section is deemed satisfactory if the make-up volume is less than 0.5L per hour per metre length per metre diameter. After any repairs, the pipeline should be re-tested.

Water Jet Cleaning

High-pressure water jet cleaning of internal pipeline surfaces is common, but if not properly managed, water emitted under high-pressure through a jet nozzle has the potential to damage any pipe surface, including those manufactured from plastics, metallic, ceramic and concrete materials.

PIPA Industry Guidelines POP205 provides information based on experience and research, as to the maximum pressures that may be used to avoid damage to StormFLO® Civil pipes. The guidelines can be downloaded at <https://pipa.com.au/technical/pop-guidelines/>



CUT-INS & REPAIRS

Cut-Ins

To cut into an existing buried StormFLO® Civil pipeline and install a socketed junction or other socketed fitting, the following procedure should be adopted:

Expose the existing pipe and cut out a length equal to the effective length of the fitting, plus approximately 600mm.

Connect 300mm long short pipes to the junction sockets and fit rubber rings to the spigot ends of the short pipes.

Fit slip couplings to the cut ends of the existing pipe and install junction.

Repairs

Depending on the severity of the damage different methods will be required to fix StormFLO® pipes. Please contact Vinidex for the best repair method or follow the Slip coupling instructions on the following pages.

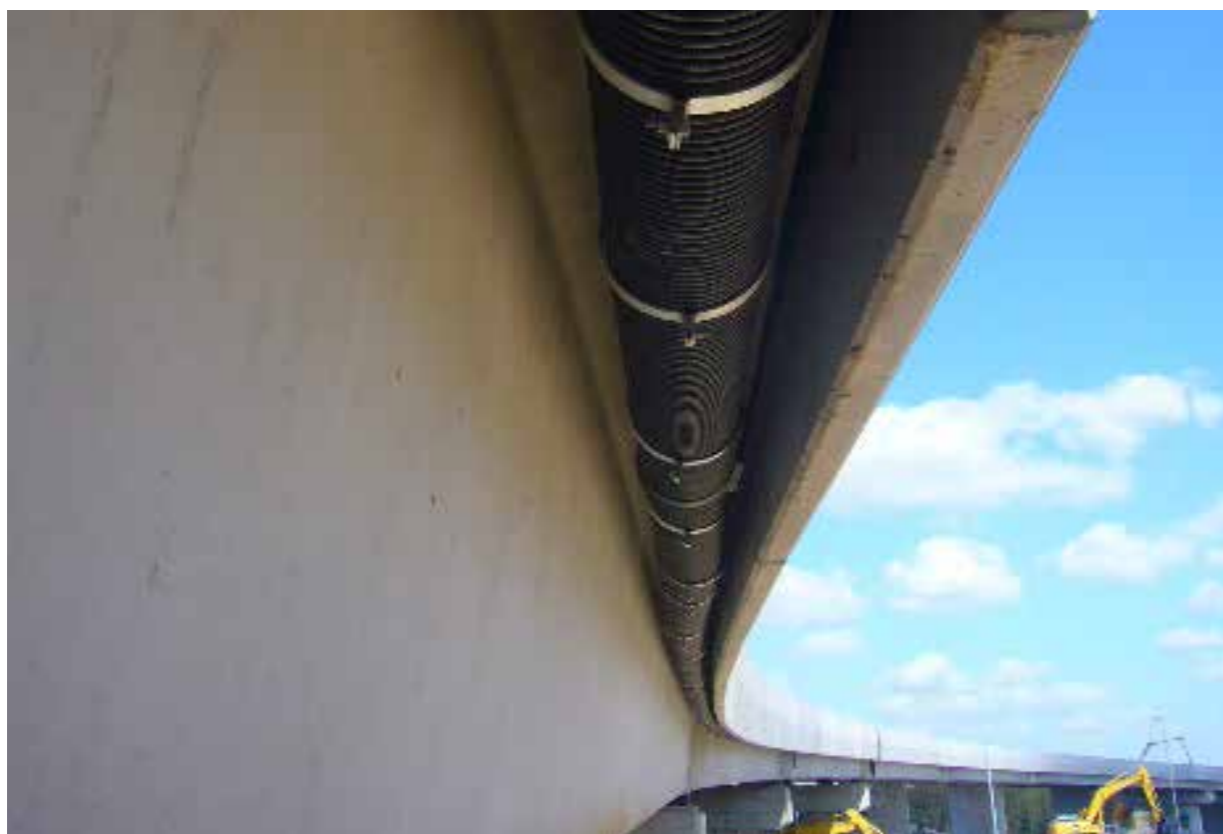

Standard and Slip Couplings

In situations where an installed section of StormFLO® Civil pipes has been damaged, that damaged section of pipe can be removed and replaced with a new section using Slip Couplings.

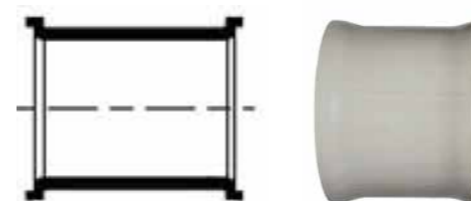

It should be noted that regardless of the size of the damaged area, a minimum length of pipe must be cut out for practical and manoeuvrability reasons. This is dependent on pipe diameter as shown in the table.

Table 10: Minimum replacement lengths for repairs using Slip couplers

DN	PRODUCT CODE	SLIP COUPLING LENGTH	MINIMUM REPLACEMENT LENGTH (MM)	NUMBER OF CORRUGATIONS
225	31500	240	760	29
300	31501	325	977	28
375	31502	320	1033	23
450	31503	338	1109	21
525	31504	432	1386	21
600	31505	487	1583	21

It is recommended that the slip coupling is assembled with two rubber rings on each spigot. A sealing ring and a support ring.

Joining Method

Step 1 Excavate

Excavate and expose the full replacement Length of the pipe plus an additional length of 600mm at each end. A minimum trench clearance of 100mm for sizes up to and including 450 and 150mm for sizes above 450 between the underside of the pipe and the trench floor is recommended.

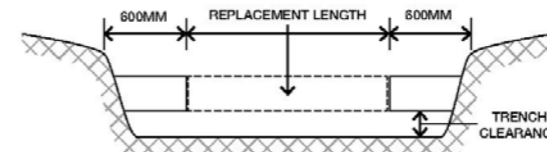

Step 2 Temporary Supports

Place temporary supports under each end of the exposed section immediately adjacent to intended cut locations, under the sections of pipe that will not be removed.

Step 3 Cut Pipe

Cut out and remove the section of the pipe to be replaced. Ensure that the cuts are square and are located in the valleys between corrugations. Clean and smooth the remaining pipe ends.

Step 4 Cut Pipe

Determine and cut the length of pipe required to achieve a neat fit between the cut ends. The maximum gap between the existing pipe and the replacement section should not exceed 10mm. Ensure that the cuts are square and are located in the valleys between corrugations. Clean and smooth the cut ends.

Step 5 Assembly & Replacement

Assemble the replacement pipe section with the slip couplings and the rubber rings as shown. This can be done beside the trench and then lowered into position in the trench.

- Ensure the inside surface of the slip couplings are clean.
- Apply a generous quantity of Vinidex jointing lubricant to the inside of the slip coupling.
- Slide one slip coupling over each spigot end of the replacement pipe. For DN 450 to DN 600 the coupling should be oriented so that the lugs on the slip coupling are towards the centre of the replacement pipe.

d. Thoroughly clean the spigot ends of the replacement pipe so that they are free of any dirt, grit or lubricant. Ensure that any lubricant that may have been transferred to the spigot valleys where the rubber rings are to be installed is removed.

Step 6 Rubber Rings

e. Install two rubber rings on spigot ends by stretching them over the spigot so that they seat in the first and second valleys from the spigot end, i.e. between the first and second corrugations and the second and third corrugations.

f. Using a bar, apply a force to the lugs or the PVC lip to push the slip coupling over the rubber rings so that the leading edge of each slip coupling is in line with the end of the replacement pipe.

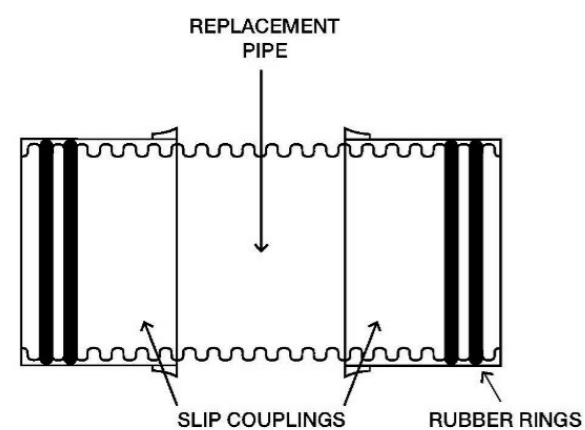

Thoroughly clean the spigot ends of the pipe in the trench making sure that they are free from dirt and grit. Hint: Lay a piece of geotextile fabric, rubber mat, poly tarp or equivalent in the trench under the ends of the existing pipe where each connection is to be made. This is to provide additional protection from dirt and contaminants being introduced into the coupling during jointing.

Step 7 Rubber Rings

Install two rubber rings on spigot ends of the pipes in the trench by stretching them over the spigot so that they seat in the first and second valleys from the spigot end, i.e. between the first and second ridges and the second and third ridges.

Step 8 Lubricant

Apply Vinidex lubricant to the top of the rubber rings.

Step 9 Position Pipe

Position the replacement pipe and set to line and grade. Align the slip couplings so that the lugs are at the 45° position.

Step 10 Bar

Using a bar, apply a force to the lugs to push the slip coupling over the rubber rings. Ensure the slip coupling is centred and aligned on the joint. Witness marks can be applied to each spigot to assist in centring the slip coupling.

Hint: The use of a stepped block between the bar and the face of the lug will significantly reduce the difficulty of pushing the slip coupling over the rings.

Hint: Having one person on each side pushing at the same time will make this a lot easier as the slip coupling will progress more evenly.



Step 11 Repeat

Repeat step 10 for the second slip coupling.

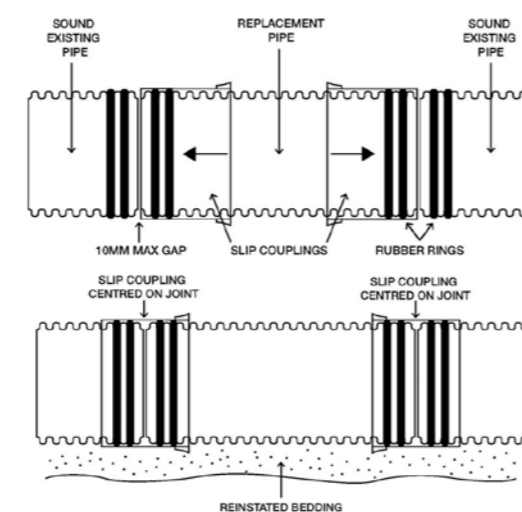

Step 12 Remove temporary pipe supports

Carefully remove the temporary pipe supports while placing embedment material under and around the replacement pipe to ensure sound support of the pipes.

Step 13 Compact

Place trench fill material in 300mm layers and compact progressively.

Step 14 Restore

Restore the surface

Contact Vinidex for a range of repair clamps and fittings for StormFLO® Civil pipes.

Leading the way, from the ground up.

For over six decades, we've been leading the way – setting the industry benchmark for pipeline systems and solutions. Our legacy spans across building, infrastructure, and agriculture sectors. We make life flow with groundbreaking, high-quality products, connecting everything from water, gas and energy throughout Australia.

Today, we maintain our commitment to innovative solutions that meet our customers' needs and exceed their expectations. Core to our approach are smarter solutions that are more sustainable throughout the manufacturing process and over their lifetime. Globally backed by Aliaxis, and a wide-reaching national footprint, our team of passionate technical experts support our customers throughout their projects – working to deliver solutions for today and the future.

Vinidex. We make life flow.

Vinidex Pty Limited
ABN 42 000 664 942

HEAD OFFICE

Level 4, 26 College Street
Darlinghurst NSW 2010
PO Box 747, Darlinghurst, NSW, 1300

Customer Service

Phone: 13 11 69
Fax: 13 24 43
Email: sales@vinidex.com.au
Web: www.vinidex.com.au



SCAN TO
FIND OUT
MORE

Limitation of Liability

This product catalogue has been compiled by Vinidex Pty Limited ("the Company") to promote better understanding of the technical aspects of the Company's products to assist users in obtaining from them the best possible performance.

The product catalogue is supplied subject to acknowledgement of the following conditions:

1 The product catalogue is protected by copyright and may not be copied or reproduced in any form or by any means in whole or in part without prior consent in writing by the Company. 2 Product specifications, usage data and advisory information may change from time to time with advances in research and field experience. The Company reserves the right to make such changes at any time without further notice. 3 Correct usage of the Company's products involves engineering judgements, which can not be properly made without full knowledge of all the conditions pertaining to each specific installation. The Company expressly disclaims all and any liability to any person whether supplied with this publication or not in respect of anything and all of the consequences of anything done or omitted to be done by any such person in reliance whether whole or part of the contents of this publication. 4 No offer to trade, nor any conditions of trading, are expressed or implied by the issue of content of this product catalogue. Nothing herein shall override the Company's Condition of Sale, which may be obtained from the Registered Office or any Sales Office of the Company. 5 This product catalogue is and shall remain the property of the Company, and shall be surrendered on demand to the Company. 6 Information supplied in this product catalogue does not override a job specification, where such conflict arises; consult the authority supervising the job. © Copyright Vinidex Pty Limited.